

ELITE SERIES

FOR MODELS :

T608



HORIZON
FITNESS

TREADMILL USER'S GUIDE

INTRODUCTION

CONGRATULATIONS and THANK YOU for your purchase of this Elite Series treadmill!

Whether your goal is to win races or simply enjoy a fuller, healthier lifestyle, an Elite Series treadmill can help you attain it—adding club-quality performance to your at-home workouts, with the ergonomics and innovative features you need to get stronger and healthier, faster. Because we're committed to designing fitness equipment from the inside out, we use only the highest quality components. It's a commitment we back with one of the strongest frame-to-motor warranty packages in the industry.

You want exercise equipment that offers the most comfort, the best reliability and the highest quality in its class.

TABLE OF CONTENTS

<i>Important Precautions</i>	4
<i>Assembly</i>	6
<i>Before You Begin</i>	12
<i>Treadmill Operation</i>	15
<i>Conditioning Guidelines</i>	26
<i>Troubleshooting & Maintenance</i>	33
<i>Limited Warranty</i>	36
CONTACT INFORMATION	<i>Back Panel</i>

IMPORTANT SAFETY INSTRUCTIONS

FOR HOUSEHOLD USE ONLY

SAVE THESE INSTRUCTIONS

Read all instructions before using this treadmill. When using an electrical product, basic precautions should always be followed, including the following: Read all instructions before using this treadmill. It is the responsibility of the owner to ensure that all users of this treadmill are adequately informed of all warnings and precautions. If you have any questions after reading this manual, contact Sears at the number listed on the back cover of this manual.



Connect this exercise product to a properly grounded outlet only. See grounding instructions.

GROUNDING INSTRUCTIONS

This product must be grounded. If a treadmill should malfunction or breakdown, grounding provides a path of least resistance for electrical current to reduce the risk of electrical shock. This product is equipped with a cord having an equipment-grounding conductor and a grounding plug. The plug must be plugged into an appropriate outlet that is properly installed and grounded in accordance with local codes and ordinances.



Improper connection of the equipment-grounding conductor can result in a risk of electric shock. Check with a qualified electrician or serviceman if you are in doubt as to whether the product is properly grounded. Do not modify the plug provided with the product. If it will not fit the outlet, have a proper outlet installed by a qualified electrician.

This product is rated more than 10 amperes and is for use on a circuit having a nominal rating of 220 - 240 volts and is factory-equipped with a specific electric cord and plug to permit connection to a proper electric circuit. Make sure that the product is connected to an outlet having the same configuration as the plug. No adapter should be used with this product. If the product must be reconnected for use on a different type of electric circuit, the reconnection should be made by qualified service personnel.



OPERATION

To reduce the risk of damaging important components on your treadmill, it is strongly recommended that your treadmill is plugged into a dedicated 16 amp circuit, without the use of an additional extension cord and/or power strip. Failure to comply may void the warranty.

IMPORTANT:

It is essential that your treadmill is used only indoors, in a climate controlled room. If your treadmill has been exposed to colder temperatures or high moisture climates, it is strongly recommended that the treadmill is warmed up to room temperature before first time use. Failure to do so may cause premature electronic failure.



TO REDUCE THE RISK OF INJURY TO PERSONS:

Stand on the siderails before starting the treadmill. Read Instruction Manual before using. Remove safety key when not in use and store out of reach of children.

When using an electrical appliance, basic precautions should always be followed, including the following. Read all instructions before using this appliance.



TO REDUCE THE RISK OF ELECTRIC SHOCK:

Always unplug this appliance (or treadmill) from the electrical outlet immediately after using and before cleaning.



TO REDUCE THE RISK OF BURNS, FIRE, ELECTRICAL SHOCK OR INJURY TO PERSONS:

- An appliance should never be left unattended when plugged in. Unplug from outlet when not in use, and before putting on or taking off parts.
- Close supervision is necessary when this appliance (or treadmill) is used by, on, or near children, invalids, or disabled persons.
- Use this appliance (or treadmill) only for its intended use as described in this manual. Do not use attachments not recommended by the manufacturer.
- Never operate this appliance (or treadmill) if it has a damaged cord or plug, if it is not working properly, if it has been dropped or damaged, or dropped into water. Return the appliance (or treadmill) to a service center for examination and repair.
- Do not carry this appliance (or treadmill) by supply cord or use cord as a handle.
- Keep the cord away from heated surfaces.
- Never operate the appliance (or treadmill) with the air openings blocked. Keep the air openings free of lint, hair, and the like.
- Never drop or insert any object into any opening.
- Do not use outdoors.
- Do not operate where aerosol (spray) products are being used or where oxygen is being administered.
- To disconnect, turn all controls to the off position, then remove plug from outlet.
- Do not operate under blanket or pillow. Excessive heating can occur and cause fire, electric shock, or injury to persons.
- Never use the treadmill before securing the safety tether clip to your clothing.
- If you experience any kind of pain, including but not limited to chest pains, nausea, dizziness, or shortness of breath, stop exercising immediately and consult your physician before continuing.
- Do not wear clothes that might catch on any part of the treadmill.
- Always wear athletic shoes while using this equipment.
- Do not jump on the treadmill.
- Unplug treadmill before moving or cleaning it. To clean, wipe surfaces down with soap and slightly damp cloth only; never use solvents. (See MAINTENANCE)
- At no time should more than one person be on treadmill while in operation.
- The treadmill should not be used by persons weighing more than 400 pounds. Failure to comply will void the warranty.
- The treadmill is intended for in-home use only. Do not use this treadmill in any commercial, rental, school or institutional setting. Failure to comply will void the warranty.
- Do not use treadmill in any location that is not temperature controlled, such as but not limited to garages, porches, pool rooms, bathrooms, car ports or outdoors. Failure to comply may void the warranty.

SAVE THESE INSTRUCTIONS



At NO time should pets or children under the age of 12 be closer to the treadmill than 10 feet. At NO time should children under the age of 12 use the treadmill.

Children over the age of 12 should not use the treadmill without adult supervision.

ASSEMBLY

IMPORTANT: READ THESE SAFETY INSTRUCTIONS BEFORE USE!



During the assembly process of the treadmill there are several areas that special attention must be paid. It is very important to follow the assembly instructions correctly and to make sure all parts are firmly tightened. If the assembly instructions are not followed correctly, the treadmill could have frame parts that are not tightened and will seem loose and may cause irritating noises. There should be no side-to-side play in the console masts or any forward and back play in the console assembly or handlebars. If there is any play in these areas, the treadmill has not been properly assembled. To prevent damage to the treadmill, the assembly instructions must be reviewed and corrective actions should be taken.

UNPACKING

Place the treadmill carton on a level flat surface. It is recommended that you place a protective covering on your floor. Take CAUTION when handling and transporting this unit. Never open box when it is on its side. Unpack the unit where it will be used. FAILURE TO FOLLOW THESE INSTRUCTIONS COULD RESULT IN INJURY!

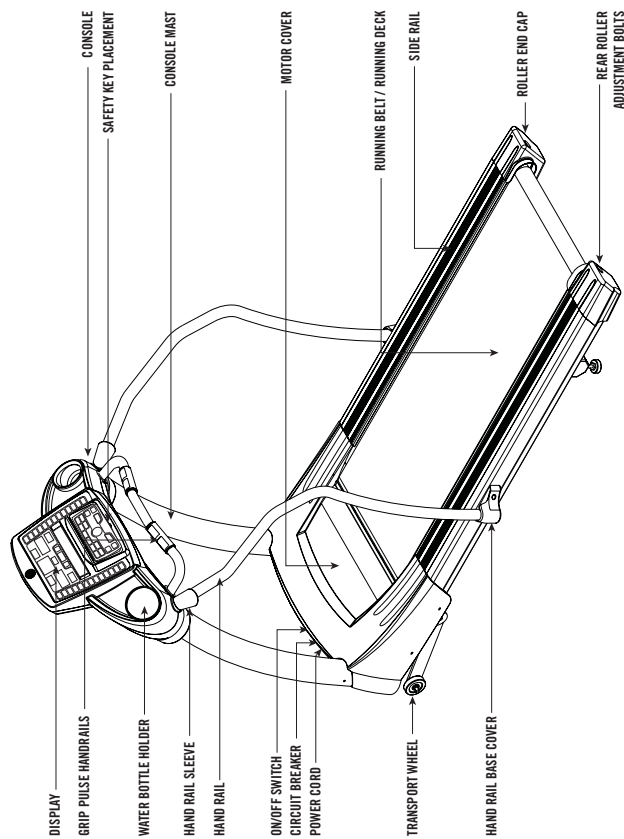

TOOLS INCLUDED

- 5 mm Allen Wrench
- 6 mm T-wrench
- 8 mm T-wrench
- Screwdriver

PARTS INCLUDED

- 1 Safety Key
- 1 Console Assembly
- 1 Power Cord
- 4 Hardware Bags
- 2 Hand Rails
- 2 Hand Rail Base Covers
- 2 Console Masts
- 2 Cup Holders
- 2 Hand Rail Sleeves

PRE-ASSEMBLY

NOTE: During each assembly step, ensure that ALL nuts and bolts are in place and partially threaded in before completely tightening any ONE bolt. **NOTE:** A light application of grease may aid in the installation of hardware. Any grease, such as lithium bike grease is recommended.

ASSEMBLY STEP 1

PINK HARDWARE BAG CONTENTS :

A Open **PINK HARDWARE BAG**.

B Connect the **CONSOLE WIRES** from the **BASE FRAME** to the bottom of the **CONSOLE MAST**.

C Attach **LEFT CONSOLE MAST** using 3 **BOLTS (A)**, 3 **SPRING WASHERS (B)** and 3 **ARC WASHERS (C)**.

D Repeat on other side.

*** NOTE:** Be careful not to pinch any wires while assembling the masts.

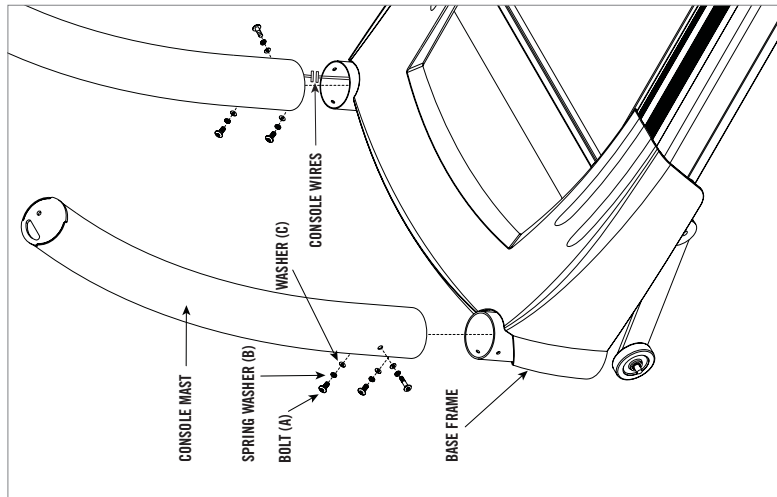

ASSEMBLY STEP 2

BLUE HARDWARE BAG CONTENTS :

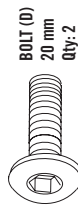
A Open **BLUE HARDWARE BAG**.

B Connect the **CONSOLE WIRES** from the **CONSOLE** to those from the top of the **MAST**.

C Attach **CONSOLE** to the **CONSOLE MASTS** using 1 **BOLT (D)**.

D Repeat on other side.

E Tighten all console bolts.

F Snap each of the **CUP HOLDERS** firmly into the **CONSOLE**.

*** NOTE:** Be careful not to pinch any wires while assembling the console.

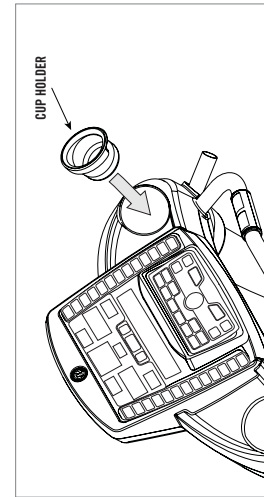
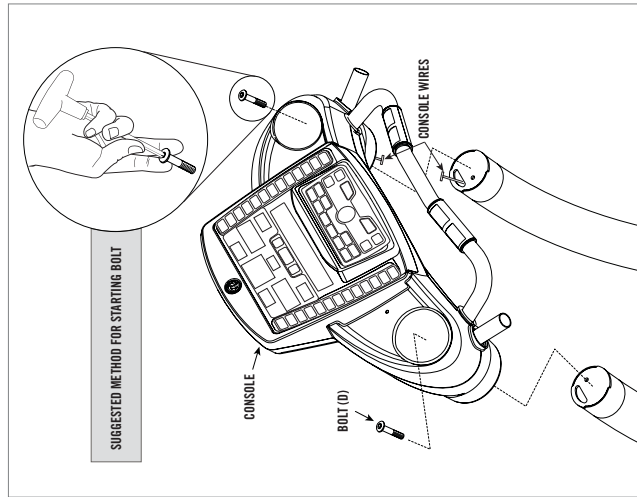

ASSEMBLY STEP 3

WHITE HARDWARE BAG CONTENTS :

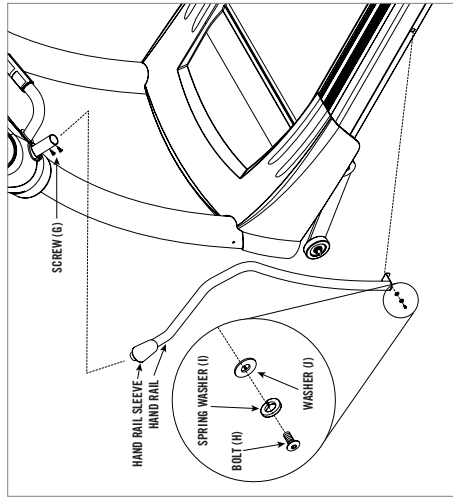
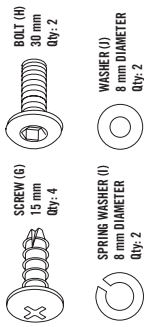

- A** Open **WHITE HARDWARE BAG**.
- B** Slide **HAND RAIL SLEEVE** over the top of the hand rail.
- C** Attach top of **HAND RAIL** to the console extension using 2 **SCREWS (G)**.
- D** Attach bottom of **HAND RAIL** to the base frame using 1 **BOLT (H)**, 1 **SPRING WASHER (I)** and 1 **WASHER (J)**.
- E** Slide **HAND RAIL SLEEVE** firmly against console.
- F** Repeat on other side.

ASSEMBLY STEP 4

ORANGE HARDWARE BAG CONTENTS :

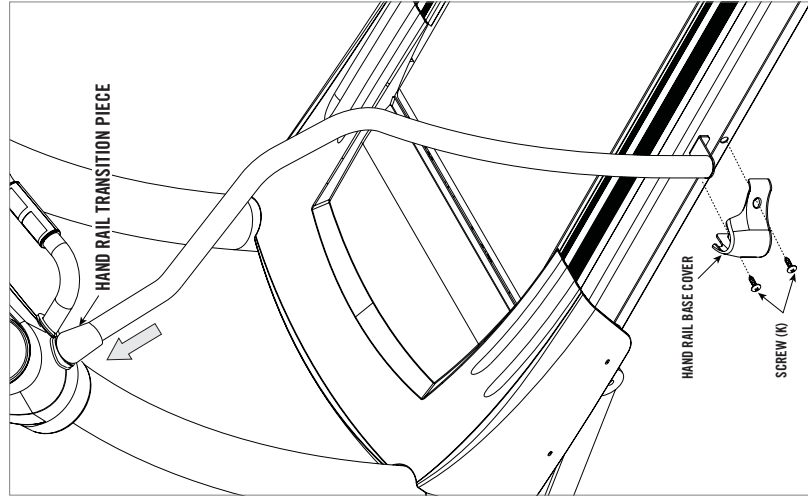
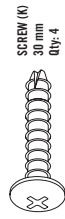

- A** Open **ORANGE HARDWARE BAG**.
- B** Attach **HAND RAIL BASE COVER** to the base frame using 2 **SCREWS (K)**.
- C** Slide **HAND RAIL TRANSITION PIECE** and **HANDLEBAR** into **CONSOLE**.
- C** Repeat on other side.
- D** Be sure all bolts and screws are tightened and secured on the treadmill.

YOU'RE FINISHED!

BEFORE YOU BEGIN

CONGRATULATIONS! on choosing your treadmill. You've taken an important step in developing and sustaining an exercise program! Your treadmill is a tremendously effective tool for achieving your personal fitness goals. Regular use of your treadmill can improve the quality of your life in so many ways.

HERE ARE JUST A FEW OF THE HEALTH BENEFITS OF EXERCISE:

- Weight Loss
- A Healthier Heart
- Improved Muscle Tone
- Increased Daily Energy Levels

The key to reaping these benefits is to develop an exercise habit. Your new treadmill will help you eliminate obstacles that prevent you from exercising. Inclement weather and darkness won't interfere with your workout when you use your treadmill in the comfort of your home. This guide provides you with basic information for using and enjoying your new machine.

LOCATION OF THE TREADMILL

Place the treadmill on a level surface. There should be 6 feet of clearance behind the treadmill, 3 feet on each side and one foot in front for folding and the power cord. Do not place the treadmill in any area that will block any vent or air openings. The treadmill should not be located in a garage, covered patio, near water or outdoors.

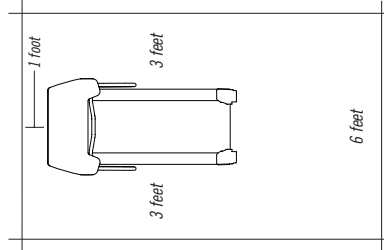

DO NOT STAND ON THE BELT

While you are preparing to use the treadmill, do not stand on the belt. Place your feet on the side rails before starting the treadmill. Start walking on the belt only after the belt has begun to move. Never start the treadmill at a fast running speed and attempt to jump on!

SAFETY KEY

Your treadmill will not start unless the safety key is placed in position. Attach the clip end securely to your clothing. This safety key is designed to cut the power to the treadmill if you should fall. Check the operation of the safety key every 2 weeks.



NEVER USE THE TREADMILL WITHOUT SECURING THE SAFETY KEY CLIP TO YOUR CLOTHING. PULL ON THE SAFETY KEY CLIP FIRST TO MAKE SURE IT WILL NOT COME OFF YOUR CLOTHING.

PROPER USAGE

Your treadmill is capable of reaching high speeds. Always start off using a slower speed and adjust the speed in small increments to reach a higher speed level. Never leave the treadmill unattended while it is running. When not in use, remove the safety key, turn the on/off switch to off and unplug the power cord. Make sure to follow the MAINTENANCE schedule in this manual. Keep your body and head facing forward. Do not attempt to turn around or look backwards while the treadmill is running. Stop your workout immediately if you feel pain, faint, dizzy or are short of breath.



Do not operate the treadmill if the power cord or plug is damaged. If the treadmill appears to not be working properly, do not use the treadmill.

MOVING

Your treadmill has a pair of transport wheels built into the frame. To move, firmly grasp the rear of the frame and carefully lift.

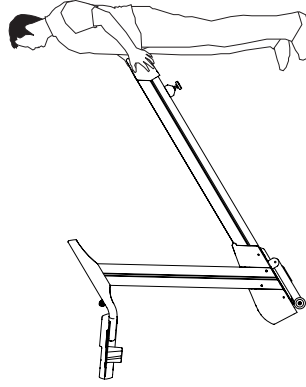

Our Treadmills are heavy, use care and additional help if necessary when moving. Failure to follow these instructions could result in injury.

TREADMILL OPERATION

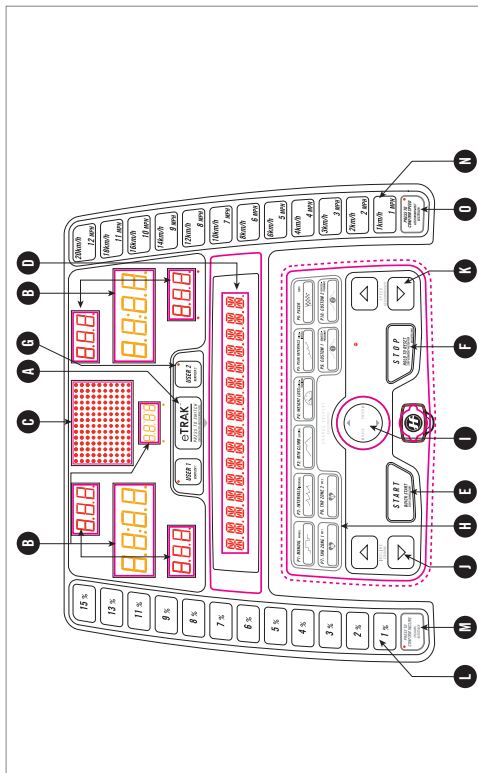

Note: There is a thin protective sheet of clear plastic on the overlay of the console and should be removed.

- A) **eTRAK™ BUTTON:** Used to scroll through eTRAK™ display modes.
- B) **LED DISPLAY WINDOWS:** Displays Heart Rate, Calories, Time, Distance, Incline, Speed, Pace, Clock and Date.
- C) **LARGE LED WINDOW:** Displays program profiles.
- D) **ALPHA-NUMERIC WINDOW:** Indicates exercise feedback and help text.
- E) **START:** Press to begin exercising, starts your program, or resume exercising after pause.
- F) **STOP:** Press to pause/end your workout. Hold for 3 seconds to reset the treadmill.
- G) **USER KEYS:** Press to select user.
- H) **QUICK PROGRAM KEYS:** Press to select program. Press ENTER to confirm selection.
- I) **PROGRAMMING BUTTON:** Used to select Program, Level and Time, and other options. Press to change display feedback during workout.
- J) **INCLINE ARROW KEYS:** Used to adjust incline in small increments (0.5% increments).
- K) **SPEED ARROW KEYS:** Used to adjust speed in small increments (0.1 mph increments).
- L) **QUICK ADJUST INCLINE KEYS:** Used to reach desired incline quickly. Press before **INCLINE CONFIRMATION KEY**.
- M) **INCLINE CONFIRMATION KEY:** Press to confirm quick adjust incline selection, necessary only when **INCREASING** incline.
- N) **QUICK ADJUST SPEED KEYS:** Used to reach desired speed quickly. Press before **SPEED CONFIRMATION KEY**.
- O) **SPEED CONFIRMATION KEY:** Press to confirm quick adjust speed selection, necessary only when **INCREASING** speed.

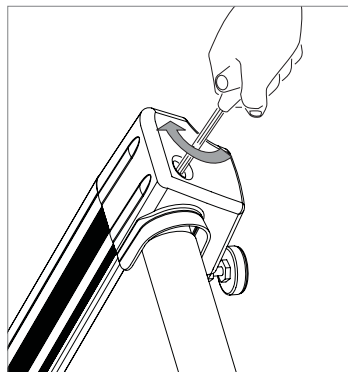

CENTERING THE RUNNING BELT

The running belt has been properly adjusted at the factory before it was shipped. At times the belt can move off-center during shipment. Before operating the treadmill, make sure the belt is centered and remains centered to maintain smooth operation.

CAUTION: Do not run belt faster than 1 mph while centering. Keep fingers, hair and clothing away from belt at all times.

If the running belt is too far to the right side:

With the treadmill running at 1 mph, turn the right adjustment bolt clockwise 1/4 TURN at a time (using the supplied Allen wrench). Check the belt alignment. Allow belt to run a full cycle to gauge if more adjustment is needed. Repeat if necessary, until the belt remains centered during use.

If the running belt is too far to the left side:

With the treadmill running at 1 mph, turn the right adjustment bolt counter-clockwise 1/4 TURN at a time (using the supplied Allen wrench). Check the belt alignment. Allow belt to run a full cycle to gauge if more adjustment is needed. Repeat if necessary, until the belt remains centered during use.

TENSIONING THE RUNNING BELT

The running belt has been properly adjusted at the factory before it was shipped. At times the belt can move off-center during shipment.

CAUTION: Running belt should NOT be moving during tensioning. Over-tightening the running belt can cause excessive wear on the treadmill as well as its components. Never over-tighten the belt.

If you can feel a slipping sensation when running on the treadmill, the running belt must be tightened. In most cases, the belt has stretched from use, causing the belt to slip. This is a normal and common adjustment. To eliminate this slipping, **TURN THE TREADMILL OFF** and tension **BOTH THE REAR ROLLER BOLTS** using the supplied Allen wrench, turning them 1/4 TURN to the right as shown. Turn the treadmill on and check for slipping. Repeat if necessary, but **NEVER TURN** the roller bolts more than 1/4 turn at a time. Belt is properly tensioned when the slipping sensation is gone.

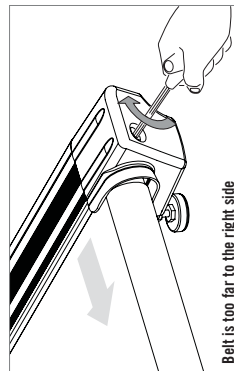

Belt is too far to the right side

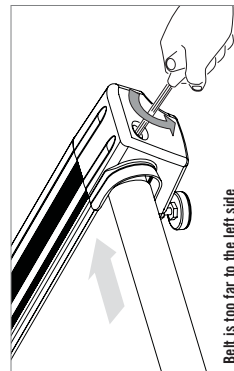

Belt is too far to the left side

MONITOR DISPLAYS

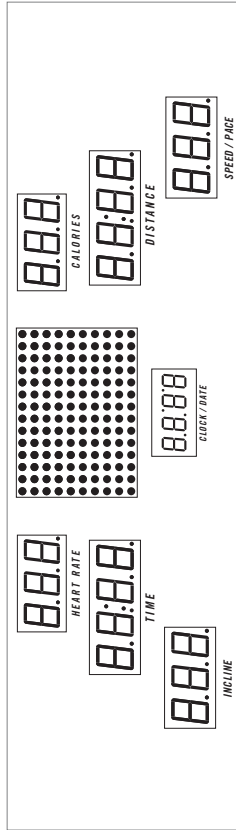

HEART RATE • Shown as BPM. Indicates your heart rate while walking or running.

CALORIES • Total Calories burned during your workout.

TIME • Shown as Minutes:Seconds and Hours:Minutes. View the time remaining or the time elapsed in your workout.

DISTANCE • Shown as Miles. Indicates distance traveled during your workout.

INCLINE • Shown as Percent. Indicates the incline of your walking or running surface.

SPEED • Shown as MPH. Indicates how fast your walking or running surface is moving.

PACE • Shown as Minutes.Tenths of a Minute. Indicates the time to run a mile at the current speed.

CLOCK • The clock displays the time of day.

DATE • Date format is month and date.

PROGRAM PROFILES • Represents the profile of the program being used (speed during speed based programs and incline during incline based programs).

HEART RATE

PULSE GRIPS

Place the palm of your hands directly on the grip pulse handlebars. Both hands must grip the bars for your heart rate to register. It takes 5 consecutive heart beats (15–20 seconds) for your heart rate to register. When gripping the pulse handlebars, do not grip tightly. Holding the grips tightly may elevate your blood pressure. Keep a loose, cupping hold. You may experience an erratic readout if consistently holding the grip pulse handlebars. Make sure to clean the pulse sensors to ensure proper contact can be maintained.

WIRELESS CHEST TRANSMITTER

Prior to wearing the wireless chest transmitter on your chest, moisten the two rubber electrodes with water. Center the chest strap just below the breast or pectoral muscles, directly over your sternum, with the logo facing out. **NOTE:** The chest strap must be tight and properly placed to receive an accurate and consistent readout. If the chest strap is too loose, or positioned improperly, you may receive an erratic or inconsistent heart rate readout. **WARNING!** The heart rate function is not a medical device. Various factors may affect the accuracy of your heart rate reading. The heart rate reading is intended only as an exercise aid.

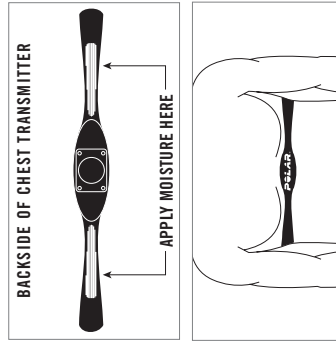

GETTING STARTED / SELECTING A PROGRAM

- 1) Check to make sure nothing is on or will hinder the movement of the treadmill.
- 2) Plug in the power cord and turn the treadmill ON.
- 3) Stand on the side rails of the treadmill.
- 4) Attach the safety key clip to part of your clothing.
- 5) Insert the safety key into the safety keyhole in the console.
- 6) You have two options to start your workout:

QUICK START UP

Simply press the **START** key to begin working out. OR...

SELECT A PROGRAM

Select a **PROGRAM** using the **QUICK PROGRAM KEYS** keys. Once a **PROGRAM** has been chosen, press **ENTER**.

SELECT A LEVEL

Select a **PROGRAM LEVEL** using the **ARROW** keys on the **PROGRAMMING** button. Once a **PROGRAM LEVEL** has been chosen, press **ENTER**.

SELECT A TIME

Select a **Time** using the **ARROW** key on the **PROGRAMMING** button or use the default time. Once a **TIME** has been chosen, press **START**.

FINISHING YOUR WORKOUT

When your workout is complete, you will hear a series of beeps. Your workout information will be displayed for 30 seconds and then reset.

CLEAR CURRENT SELECTION

To clear the current program selection or screen, hold the **STOP** button for 3 seconds.

PROGRAM INFORMATION

PROGRAM: MANUAL

Allows 'On The Fly' manual **SPEED** and **INCLINE** changes. Time-based goal.

PROGRAM: INTERVALS

Walk or run a series of alternating **SPEED** levels. Time-based goal with 12 difficulty levels to choose from.

INTERVALS PROGRAM SEGMENTS

(peak segments last 30 seconds, valley segments last 90 seconds)

Level	Warm-Up				Incline				Cool Down			
	1	2	3	4	1	2	3	4	1	2	3	4
Level 1	1.0	1.5	2.0	4.0	2.0	4.0	2.0	4.0	1.5	1.0	1.5	1.0
Level 2	1.0	1.5	2.0	4.5	2.0	4.5	2.0	4.5	1.5	1.0	1.5	1.0
Level 3	1.3	1.9	2.5	5.0	2.5	5.0	2.5	5.0	1.9	1.3	1.9	1.3
Level 4	1.3	1.9	2.5	5.5	2.5	5.5	2.5	5.5	1.9	1.3	1.9	1.3
Level 5	1.5	2.3	3.0	6.0	3.0	6.0	3.0	6.0	2.3	1.5	2.3	1.5
Level 6	1.5	2.3	3.0	6.5	3.0	6.5	3.0	6.5	2.3	1.5	2.3	1.5
Level 7	1.8	2.6	3.5	7.0	3.5	7.0	3.5	7.0	2.6	1.8	2.6	1.8
Level 8	1.8	2.6	3.5	7.5	3.5	7.5	3.5	7.5	2.6	1.8	2.6	1.8
Level 9	2.0	3.0	4.0	8.0	4.0	8.0	4.0	8.0	3.0	2.0	3.0	2.0
Level 10	2.0	3.0	4.0	8.5	4.0	8.5	4.0	8.5	3.0	2.0	3.0	2.0
Level 11	2.3	3.5	4.5	9.0	4.5	9.0	4.5	9.0	3.0	2.0	3.0	2.0
Level 12	2.3	3.5	4.5	9.5	4.5	9.5	4.5	9.5	3.0	2.0	3.0	2.0

(WARM-UP and COOL-DOWN last 5:00 minutes each and are included in program times)

PROGRAM: MOUNTAIN CLIMB

Simulates climbing and descending a mountain by automatically varying **INCLINE**. 12 difficulty levels to choose from.

Level	Incline											
	1	2	3	4	5	6	7	8	9	10	11	12
1	0.0	1.0	1.5	2.0	2.5	3.0	3.0	2.5	2.0	1.5	1.0	0.0
2	0.0	1.5	2.0	2.5	3.0	3.5	3.5	3.0	2.5	2.0	1.5	0.0
3	0.0	2.0	2.5	3.0	3.5	4.0	4.0	3.5	3.0	2.5	2.0	1.0
4	0.0	2.5	3.0	3.5	4.0	4.5	4.5	4.0	3.5	3.0	2.5	1.5
5	0.0	3.0	3.5	4.0	4.5	5.0	5.0	4.5	4.0	3.5	3.0	1.5
6	0.0	3.5	4.0	4.5	5.0	5.5	5.5	5.0	4.5	4.0	3.5	1.5
7	0.0	4.0	4.5	5.0	5.5	6.0	6.0	5.5	5.0	4.5	4.0	1.5
8	0.0	4.5	5.0	5.5	6.0	6.5	6.5	6.0	5.5	5.0	4.5	2.0
9	0.0	5.0	5.5	6.0	6.5	7.0	7.0	6.5	6.0	5.5	5.0	2.0
10	0.0	5.5	6.0	6.5	7.0	7.5	7.5	7.0	6.5	6.0	5.5	2.0
11	1.0	2.0	3.0	4.0	5.0	6.0	6.0	5.5	5.0	4.5	4.0	2.0
12	1.0	2.0	3.0	4.0	5.0	6.0	6.0	5.5	5.0	4.5	4.0	2.0

(WARM-UP and COOL-DOWN last 5:00 minutes each and are included in program times)



PROGRAM: WEIGHT LOSS

Challenges with various combinations of hills and valleys (**INCLINE** & **SPEED** levels). Time-based goal with 12 difficulty levels to choose from.

WEIGHT LOSS PROGRAM SEGMENTS (all segments last 30 seconds)

Level	Warm-Up												Segments are repeated until selected time is reached												Cool-Down		
	1	2	3	4	5	6	7	8	9	10	11	12	1	2	3	4	5	6	7	8	9	10	11	12	0.5	0.0	
Level 1	Elevation	0.0	0.5	1.5	1.0	0.5	0.5	0.5	0.5	0.5	0.5	1.0	1.5	1.0	0.5	0.5	0.5	0.5	1.0	1.5	1.0	0.5	0.5	0.0	0.5	0.0	
	Speed	1.0	1.5	2.0	2.5	3.0	3.5	4.0	3.5	4.0	3.5	3.0	2.5	2.0	1.5	1.5	1.5	1.5	1.0	1.5	2.0	2.5	3.0	2.5	2.3	1.5	
Level 2	Elevation	0.0	0.5	1.5	1.0	0.5	1.0	0.5	1.0	0.5	1.0	1.5	2.0	1.5	1.0	0.5	1.0	0.5	1.0	1.5	2.0	1.5	1.0	0.5	0.0	0.5	0.0
	Speed	1.3	1.9	2.5	3.0	3.5	4.0	4.5	4.0	4.5	4.0	3.5	3.0	2.5	2.0	2.0	2.0	2.0	1.5	2.0	2.5	3.0	2.5	2.6	1.8		
Level 3	Elevation	0.5	1.0	2.0	2.0	1.5	1.0	1.0	1.0	1.0	1.0	1.5	2.0	2.0	1.5	1.0	1.0	1.0	1.5	2.0	2.5	2.0	1.5	1.0	0.5	1.0	0.5
	Speed	1.5	2.3	3.0	3.5	4.0	4.5	5.0	4.5	5.0	4.5	4.0	3.5	3.0	2.5	2.5	2.5	2.5	2.0	2.5	3.0	3.5	3.0	3.0	2.0		
Level 4	Elevation	0.5	1.0	2.0	2.0	1.5	1.0	1.0	1.0	1.0	1.0	1.5	2.0	2.0	1.5	1.0	1.0	1.0	1.5	2.0	2.5	2.0	1.5	1.0	0.5	1.0	0.5
	Speed	1.8	2.6	3.5	4.0	4.5	5.0	5.5	5.0	5.5	5.0	4.5	4.0	3.5	3.4	3.4	3.4	3.4	2.9	3.4	3.9	4.4	3.9	3.4	2.3		
Level 5	Elevation	1.0	1.5	2.5	2.5	2.0	1.5	1.5	1.5	1.5	1.5	2.0	2.5	2.5	2.0	1.5	1.5	1.5	2.0	2.5	3.0	2.5	2.0	1.5	1.0	0.5	1.0
	Speed	2.0	3.0	4.0	4.5	5.0	5.5	6.0	6.5	6.0	6.5	7.0	7.5	7.0	6.5	6.0	6.5	7.0	7.5	8.0	8.5	8.0	7.5	7.0	6.5	6.0	
Level 6	Elevation	1.0	1.5	2.5	2.5	2.0	1.5	1.5	1.5	1.5	1.5	2.0	2.5	2.5	2.0	1.5	1.5	1.5	2.0	2.5	3.0	2.5	2.0	1.5	1.0	0.5	1.0
	Speed	2.3	3.4	4.5	5.0	5.5	6.0	6.5	6.0	6.5	7.0	7.5	8.0	7.5	7.0	6.5	6.0	6.5	7.0	7.5	8.0	8.5	8.0	7.5	7.0	6.5	
Level 7	Elevation	1.5	2.0	3.0	3.0	2.5	2.0	2.0	2.0	2.0	2.0	2.5	3.0	3.0	2.5	2.0	2.0	2.0	2.5	3.0	3.5	3.0	2.5	2.0	1.5	1.0	0.5
	Speed	2.5	3.8	5.0	5.5	6.0	6.5	7.0	6.5	7.0	7.5	8.0	8.5	8.0	7.5	7.0	6.5	6.0	6.5	7.0	7.5	8.0	7.5	7.0	6.5	6.0	
Level 8	Elevation	1.5	2.0	3.0	3.0	2.5	2.0	2.0	2.0	2.0	2.0	2.5	3.0	3.0	2.5	2.0	2.0	2.0	2.5	3.0	3.5	3.0	2.5	2.0	1.5	1.0	0.5
	Speed	2.8	4.1	5.5	6.0	6.5	7.0	7.5	7.0	7.5	8.0	8.5	9.0	8.5	8.0	7.5	7.0	6.5	7.0	7.5	8.0	8.5	8.0	7.5	7.0	6.5	
Level 9	Elevation	2.0	2.5	3.5	3.5	3.0	2.5	2.5	2.5	2.5	2.5	3.0	3.5	3.5	3.0	2.5	2.5	2.5	3.0	3.5	4.0	3.5	3.0	2.5	2.0	1.5	1.0
	Speed	3.0	4.5	6.0	6.5	7.0	7.5	8.0	7.5	8.0	8.5	9.0	9.5	9.0	8.5	8.0	7.5	7.0	7.5	8.0	8.5	9.0	8.5	8.0	7.5	7.0	6.5
Level 10	Elevation	2.0	2.5	3.5	3.5	3.0	2.5	2.5	2.5	2.5	2.5	3.0	3.5	3.5	3.0	2.5	2.5	2.5	3.0	3.5	4.0	3.5	3.0	2.5	2.0	1.5	1.0
	Speed	3.3	4.9	6.5	7.0	7.5	8.0	8.5	8.0	8.5	9.0	9.5	10.0	9.5	9.0	8.5	8.0	7.5	8.0	8.5	9.0	9.5	9.0	8.5	8.0	7.5	7.0
Level 11	Elevation	2.5	3.0	4.0	4.0	4.0	4.0	4.0	4.0	4.0	4.0	4.5	5.0	5.0	4.5	4.0	4.0	4.0	4.5	5.0	5.5	5.0	4.5	4.0	3.5	3.0	2.5
	Speed	4.0	5.0	7.0	7.5	8.0	8.5	9.0	8.5	9.0	9.5	10.0	10.5	10.0	9.5	9.0	8.5	8.0	8.5	9.0	9.5	10.0	10.5	10.0	9.5	9.0	8.5
Level 12	Elevation	3.0	3.5	4.0	4.0	4.0	4.0	4.0	4.0	4.0	4.5	5.0	5.5	5.5	5.0	4.5	4.5	4.5	5.0	5.5	6.0	6.5	6.5	6.0	5.5	5.0	4.0
	Speed	5.0	6.0	8.0	8.0	8.0	8.0	8.0	8.0	8.0	8.5	9.0	9.5	9.0	8.5	8.0	7.5	7.0	7.5	8.0	8.5	9.0	8.5	8.0	7.5	7.0	6.5

(WARM-UP and COOL-DOWN last 5:00 minutes each and are included in program times)

PROGRAM: PEAK INTERVALS

Challenges with various combinations of hills and valleys (**INCLINE & SPEED** levels). Time-based goal with 12 difficulty levels to choose from.

PEAK INTERVALS PROGRAM SEGMENTS (Peak segments last 30 seconds; valley segments last 90 seconds)

	WARM-DOWN		1	2	3	4	5	6	7	8	COOL-DOWN		
Level 1	Elevation	1.0	1.5	1.0	2.0	1.0	2.0	1.0	2.5	1.0	2.5	1.5	1.0
	Speed	1.0	1.5	2.0	4.0	2.0	4.0	2.0	4.5	2.0	4.5	1.5	1.0
Level 2	Elevation	1.0	1.5	1.0	2.5	1.0	2.5	1.5	3.0	1.5	3.0	1.5	1.0
	Speed	1.0	1.5	2.0	4.5	2.0	4.5	2.5	5.0	2.5	5.0	1.5	1.0
Level 3	Elevation	1.0	1.5	1.5	3.0	1.5	3.0	1.5	3.5	1.5	3.0	1.5	1.0
	Speed	1.3	1.9	2.5	5.0	2.5	5.0	2.5	5.5	2.5	5.5	1.9	1.3
Level 4	Elevation	1.0	1.5	1.5	3.5	1.5	3.0	2.0	4.0	2.0	4.0	1.5	1.0
	Speed	1.3	1.9	2.5	5.5	2.5	5.5	3.0	6.0	3.0	6.0	1.9	1.3
Level 5	Elevation	1.5	2.0	2.0	4.0	2.0	4.0	2.0	4.5	2.0	4.5	2.0	1.5
	Speed	1.5	2.3	3.0	6.0	3.0	6.0	3.0	6.5	3.0	6.5	2.3	1.5
Level 6	Elevation	1.5	2.0	2.0	4.5	2.0	4.5	2.0	5.0	2.0	5.0	2.0	1.5
	Speed	1.5	2.3	3.0	6.5	3.0	6.5	3.5	7.0	3.5	7.0	2.3	1.5
Level 7	Elevation	1.5	2.5	2.0	5.0	2.0	5.0	2.0	5.5	2.0	5.5	2.5	1.5
	Speed	1.8	2.6	3.5	7.0	3.5	7.0	3.5	7.5	3.5	7.5	2.6	1.8
Level 8	Elevation	1.5	2.5	2.0	5.5	2.0	5.5	2.0	6.0	2.0	6.0	2.5	1.5
	Speed	1.8	2.6	3.5	7.5	3.5	7.5	4.0	8.0	4.0	8.0	2.6	1.8
Level 9	Elevation	2.0	3.0	2.5	6.0	2.5	6.0	2.5	6.5	2.5	6.5	3.0	2.0
	Speed	2.0	3.0	4.0	8.0	4.0	8.0	4.0	8.5	4.0	8.5	3.0	2.0
Level 10	Elevation	2.0	3.0	2.5	6.5	2.5	6.5	2.5	7.0	2.5	7.0	3.0	2.0
	Speed	2.0	3.0	4.0	8.5	4.0	8.5	4.5	9.0	4.5	9.0	3.0	2.0
Level 11	Elevation	2.0	3.5	2.5	7.0	2.5	7.0	2.5	7.5	2.5	7.5	3.5	2.0
	Speed	2.3	3.5	4.5	9.0	4.5	9.0	4.5	9.5	4.5	9.5	3.5	2.3
Level 12	Elevation	2.0	3.5	3.0	7.5	3.0	7.5	3.0	8.0	3.0	8.0	3.5	2.0
	Speed	2.3	3.5	4.5	9.5	4.5	9.5	5.5	10.0	5.5	10.0	3.5	2.3

(WARM-UP and COOL-DOWN last 5:00 minutes each and are included in program times)

PROGRAM: PACER

Trains you to run at a steady 5 minute warm up and cool down "race pace." Enter in the distance plus the time limit and the program calculates a steady pace or simply press the start button for a pre-set speed.

**PROGRAM: THR ZONE 1**

Automatically adjusts incline to maintain your Target Heart Rate. Perfect for simulating the intensity of your favorite sport or everyday activity. Time-based goal.

1. Once the **THR ZONE** program has been chosen, press **ENTER**.
2. Choose a **TARGET HEART RATE** using the **ARROW KEYS** on the programming button and press **ENTER**.
Note: Use the chart provided in this guide, to determine your target heart rate.
3. Choose a time using the **ARROW** key on the **PROGRAMMING** button or use the default time.
4. Press **START** to begin your program. At this time, your program has been successfully saved into memory, and can be used for future workouts.

- To **RESET** your program information and delete it from memory, press and hold the **ENTER** key for 5 seconds (after you have selected the **THR ZONE 1** or **2** program).

In this program, the large LED dot matrix window displays your heart rate during exercise. The middle row represents your target heart rate (THR) and the other rows equal +/-2 heart beats. If you are working out beneath your THR, the LEDs **BELOW** the middle row will illuminate. If you are over, the LEDs **ABOVE** the middle row will illuminate. Your current heart rate is represented by the flashing column and the window will refresh every 5 seconds.

NOTE: If no heart rate is detected, the large LED window will display the incline profile.

After the warm-up period, the **INCLINE** level will increase gradually to get you to the entered **TARGET HEART RATE ZONE**. Once you are at the **TARGET HEART RATE ZONE** (plus or minus 5 beats per minute) the **INCLINE** level will remain until you rise above or drop below your **TARGET HEART RATE ZONE** at which time the incline would adjust accordingly. If there is no heart rate detected, the incline will not change. If your heart rate is 25 beats over your target zone the program will shut down. There is a cool down at the end of the program. At this time, the program will gradually decrease the incline level to give you a smooth cool down.

**PROGRAM: THR ZONE 2**

Automatically adjusts speed to maintain your Target Heart Rate. Perfect for simulating the intensity of your favorite sport or everyday activity. Time-based goal.

1. Once the **THR ZONE** program has been chosen, press **ENTER**.
2. Choose a **TARGET HEART RATE** using the **ARROW KEYS** on the programming button and press **ENTER**.
Note: Use the chart provided in this guide, to determine your target heart rate.
3. Choose a time using the **ARROW** key on the **PROGRAMMING** button or use the default time.
4. Press **START** to begin your program. At this time, your program has been successfully saved into memory, and can be used for future workouts.

- To **RESET** your program information and delete it from memory, press and hold the **ENTER** key for 5 seconds (after you have selected the **THR ZONE 1** or **2** program).

In this program, the large LED dot matrix window displays your heart rate during exercise. The middle row represents your target heart rate (THR) and the other rows equal +/-2 heart beats. If you are working out beneath your THR, the LEDs **BELOW** the middle row will illuminate. If you are over, the LEDs **ABOVE** the middle row will illuminate. Your current heart rate is represented by the flashing column and the window will refresh every 5 seconds.

NOTE: If no heart rate is detected, the large LED window will display the speed profile.

After the warm-up period, the **SPEED** level will increase gradually to get you to the entered **TARGET HEART RATE ZONE**. Once you are at the **TARGET HEART RATE ZONE** (plus or minus 5 beats per minute) the **SPEED** level will remain until you rise above or drop below your **TARGET HEART RATE ZONE** at which time the speed would adjust accordingly. If there is no heart rate detected, the speed will not change. If your heart rate is 25 beats over your target zone the program will shut down. There is a cool down at the end of the program. At this time, the program will gradually decrease the speed level to give you a smooth cool down.

PROGRAM: CUSTOM 1 & 2

Lets you create and reuse a perfect workout for you with specific speed, incline and time combination. The ultimate in personal programming. Time-based goal.

1. Once the **CUSTOM 1** or **2** program has been chosen, press **ENTER**
 2. Choose the desired **TIME** using the **ARROW KEYS** on the programming button and press **ENTER**.
 3. Choose the desired **SPEED** for each segment, using the **ARROW KEYS** on the programming button and press **ENTER**. **Note:** You will need to press **ENTER** after each segment.
 4. Choose the desired **INCLINE** for each segment, using the **ARROW KEYS** on the programming button and press **ENTER**. **Note:** You will need to press **ENTER** after each segment.
 5. Press **START** to begin your program. At this time, your program has been successfully saved into memory, and can be used for future workouts.
- To **RESET** your program information and delete it from memory, press and hold the **ENTER** key for 5 seconds (after you have selected the **CUSTOM 1** or **2** program).
 - While using your saved program, you are able to adjust the speed or incline, but any changes will not be saved.

PROGRAM INFORMATION

USING eTRAK™ PERFORMANCE TRACKER

INTRODUCTION

Research shows that those who journal their fitness routines or workouts, on average, achieve greater success than those who do not. Because your new treadmill is equipped with Horizon's exclusive eTRAK™ Performance Tracker, you've taken an important step towards achieving your fitness goals. Congratulations!

eTRAK™ is an innovative new software integrated into your treadmill console, that will allow you to track your fitness progress over time without the need for paper journals or logs. eTRAK™ allows you to easily compare your current workout to your last, average or lifetime workout totals. With quick access to feedback like time of workout or calories burned during previous workouts, you'll be able to quickly and easily see the progress you've made. Read further to learn about how eTRAK™ can help motivate you to enhance your performance.

DATE & CLOCK SETUP

- 1) Enter Setup Mode: Press and hold **MANUAL** and **INTERVALS** program buttons for 3 seconds.
- 2) Once in setup mode, use the **PROGRAMMING ARROW KEYS** to scroll through settings.
- 3) Use the **ENTER** button to confirm settings.
- 4) Settings include: **MONTH, DAY, YEAR, HOUR, MINUTE, and AM/PM.**
- 5) Review Settings: You can review your settings at any time while in Setup Mode. Use the **ENTER** button to scroll through settings.
- 6) Exit Setup Mode: To confirm the Date and Time, press and hold **ENTER** for 5 seconds.
- 7) To Reset: Simply reenter Setup Mode and adjust Date and Time to the correct setting.

eTRAK™ OPERATION

SETUP: To activate eTRAK™ a user **MUST** be chosen before the program begins. To select a user, simply press the User 1 or User 2 button. To deselect a user, press User button again. All accumulated data specifically relates to the user that is chosen. Note: If no user is selected, no data will be tracked.

RESET: Reset all recorded information for User 1 or User 2 by selecting the user and then holding down the user button for 10 seconds. Note: This step is permanent and will delete ALL previously accumulated data for the chosen user.

ACCUMULATED DATA: Once eTRAK™ is activated, you can scroll through your accumulated data in multiple formats by pressing the eTRAK™ button. A workout is saved when: the program ends, the console is paused and not resumed within five minutes, or the stop button is held to reset the console.

- 1) **CURRENT WORKOUT:** The console automatically defaults to Current Workout, displaying your progress in real time.
- 2) **AVERAGE WORKOUT:** This option allows you to see your average accumulated data for the last 100 workouts. The following information will be shown in each display window:
 INCLINE - Average incline level.
 TIME - Average workout time.
 CALORIES - Average calories burned.

PACE - Average pace of workout.
DISTANCE - Average workout distance.
SPEED - Average speed of workout.

- 3) **LAST WORKOUT:** This option allows you to view your accumulated data from your last workout. The Current Workout becomes the Last Workout once a program has ended or the console has been reset. The following information will be shown in each display window:
 INCLINE - Average incline of last workout.
 TIME - Total time of last workout.
 CALORIES - Total calories burned during last workout.

PACE - Average pace of last workout.
DISTANCE - Total distance of last workout.
SPEED - Average speed of last workout.

eTRAK OPERATION

- 4) **WEEKLY TOTAL:** View your accumulated data from the last Sunday to the present day. Note: This data is based on week to date **NOT** the previous seven days. For instance, if you have not used the machine since Sunday, the console will read zeros. The following information will be shown in each display window:
 INCLINE - Average incline of weekly workout.
 TIME - Total time of workout.
 CALORIES - Average calories burned.

PACE - Average pace of weekly workout.
DISTANCE - Total distance of workout.
SPEED - Average speed of weekly workout.

Note: If the Date and Clock are not set, Weekly Total will default to the Total Workout data.

- 5) **MONTHLY TOTAL:** View your accumulated data from the 1st day of the month to the present day. Note: This data is based on month to date **NOT** the previous thirty days. For instance, if you have not used the machine since the 1st of the month, the console will read zeros. The following information will be shown in each display window:
 INCLINE - Average incline of monthly workout.
 TIME - Total time of monthly workout.
 CALORIES - Average calories burned.

PACE - Average pace of monthly workout.
DISTANCE - Total distance of workout.
SPEED - Average speed of monthly workout.

Note: If the Date and Clock are not set, Monthly Total will default to equal the Total Workout data.

- 6) **LIFETIME TOTAL:** This option allows you to view the the total accumulated data from your first workout to your last saved workout. The following information will be shown in each display window:
 INCLINE - Average incline.
 TIME - Total accumulated time. Note: If time is greater than 99:59, the time will no longer display minutes and will display hours only.

CALORIES - Average calories burned.
PACE - Average pace.
DISTANCE - Total accumulated distance.
SPEED - Average speed.

CONDITIONING GUIDELINES

ALWAYS CONSULT YOUR PHYSICIAN BEFORE BEGINNING AN EXERCISE PROGRAM.

HOW OFTEN? (Frequency of Workouts)

The American Heart Association recommends that you exercise at least 3 to 4 days per week to maintain cardiovascular fitness. If you have other goals such as weight or fat loss, you will achieve your goal faster with more frequent exercise. Whether it's 3 days or 6 days, remember that your ultimate goal should be to make exercise a lifetime habit. Many people are successful staying with a fitness program if they set aside a specific time of day to exercise. It doesn't matter whether it's in the morning before breakfast, during lunch hour or while watching the evening news. What's more important is that it's a time that allows you to keep a schedule, and a time when you won't be interrupted. To be successful with your fitness program, you have to make it a priority in your life. So decide on a time, pull out your day planner and pencil in your exercise times for the next month!

HOW LONG? (Duration of Workouts)

For aerobic exercise benefits, it's recommended that you exercise from between 24 and 60 minutes per session. But start slowly and gradually increase your exercise times. If you've been sedentary during the past year, it may be a good idea to keep your exercise times to as little as five minutes initially. Your body will need time to adjust to the new activity. If your goal is weight loss, a longer exercise session at lower intensities has been found to be most effective. A workout time of 48 minutes or more is recommended for best weight loss results.

HOW HARD? (Intensity of Workouts)

How hard you workout is also determined by your goals. If you use your treadmill to prepare for a 5K run, you will probably work out at a higher intensity than if your goal is general fitness. Regardless of your long term goals, always begin an exercise program at low intensity. Aerobic exercise does not have to be painful to be beneficial! There are two ways to measure your exercise intensity. The first is by monitoring your heart rate (using the grip pulse handlebars or a wireless chest transmitter - may be sold separately), and the second is by evaluating your perceived exertion level (this is simpler than it sounds!).

PERCEIVED EXERTION LEVEL

A simple way to gauge your exercise intensity is to evaluate your perceived exertion level. While exercising, if you are too winded to maintain a conversation without gasping, you are working out too hard. A good rule of thumb is to work to the point of exhilaration, not exhaustion. If you cannot catch your breath, it's time to slow down. Always be aware of these warning signs of overexertion.

TARGET HEART RATE ZONE CHART

What is Target Heart Rate Zone?

Target Heart Rate Zone tells you the number of times per minute your heart needs to beat to achieve a desired workout effect. It is represented as a percentage of the maximum number of times your heart can beat per minute. Target Zone will vary for each individual, depending on age, current level of conditioning, and personal fitness goals. The American Heart Association recommends working-out at a Target Heart Rate Zone of between 60% and 75% of your maximum heart rate. A beginner will want to workout in the 60% range while a more experienced exerciser will want to workout in the 70-75% range. See chart for reference.

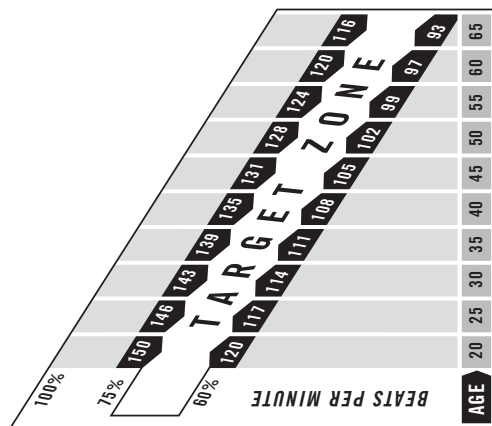

EXAMPLE:

For a 42-year-old user. Find age along the bottom of the chart (round to 40), follow age column up to the target zone bar. Results: 60% of maximum Heart Rate = 108 Beats Per Minute, 75% of maximum Heart Rate = 135 Beat Per Minute.

ALWAYS CONSULT YOUR PHYSICIAN BEFORE BEGINNING AN EXERCISE PROGRAM.

TIPS

STRETCHING

STRETCH FIRST

Before using your product, it is best to take a few minutes doing a few gentle stretching exercises. Stretching prior to exercise will improve flexibility and reduce chances of exercise related injury. Ease into each of these stretches with a slow gentle motion. Do not stretch to the point of pain. Make sure not to bounce while doing these stretches.

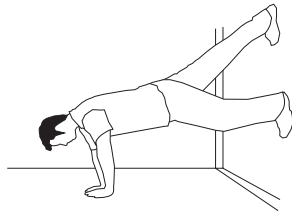

1. STANDING CALF MUSCLE STRETCH

Stand near a wall with the toes of your left foot about 18" from the wall, and the right foot about 12" behind the other foot. Lean forward, pushing against the wall with your palms. Keep your heels flat and hold this position for a count of 15 seconds. Make sure that you do not bounce while stretching. Repeat on the other side.

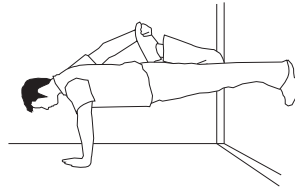

2. STANDING QUADRICEPS STRETCH

Using a wall to provide balance, grasp your left ankle with your left hand and hold your foot against the back of your thigh for 15 seconds. Repeat with your right ankle and hand.

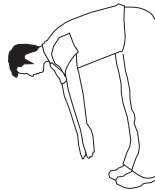

3. SITTING HAMSTRING & LOWER BACK MUSCLE STRETCH

Sit on the floor with your legs together and straight out in front of you. Do not lock your knees. Extend your fingers towards your toes and hold for a count of 15 seconds. Make sure that you do not bounce while stretching. Sit upright again. Repeat one time.

TIPS

THE IMPORTANCE OF WARM UP & COOL DOWN

WARM UP

The first 2 to 5 minutes of a workout should be devoted to warming up. The warm-up will limber your muscles and prepare them for more strenuous exercise. Make sure that you warm-up on your product at a slow pace. The warm up should gradually bring your heart rate into your Target Heart Rate Zone.

COOL DOWN

Never stop exercising suddenly! A cool-down period of 3-5 minutes allows your heart to readjust to the decreased demand. Make sure that your cool down period consists of a very slow pace to allow your heart rate to lower. After the cool-down, repeat the stretching exercises listed above to loosen and relax your muscles.

TIPS

ACHIEVING YOUR FITNESS GOALS

An important step in developing a long term fitness program is to determine your goals. Is your primary goal for exercising to lose weight? Improve muscle? Reduce stress? Prepare for the spring racing schedule? Knowing what your goals are will help you develop a more successful exercise program. Below are some common exercise goals:

- Weight Loss - lower intensity, longer duration workouts
- Improve Body Shape and Tone - interval workouts, alternate between hi and low intensities
- Increased Energy Level - more frequent daily workouts
- Improved Sports Performance - high intensity workouts
- Improved Cardiovascular Endurance - moderate intensity, longer duration workouts

If possible try to define your personal goals in precise, measurable terms, and then put your goals in writing. The more specific you can be, the easier it will be to track your progress. If your goals are long term, divide them up into monthly and weekly segments. Longer term goals can lose some of the immediate motivation benefits. Short term goals are easier to achieve. Your console provides you with several readouts that can be used to record your progress. You can track Distance, Calories or Time.

WEEKLY LOG SHEETS

WEEK # _____		WEEKLY GOAL _____			
DAY	DATE	DISTANCE	CALORIES	TIME	COMMENTS
SUNDAY					
MONDAY					
TUESDAY					
WEDNESDAY					
THURSDAY					
FRIDAY					
SATURDAY					
WEEKLY TOTALS :					

WEEK # _____		WEEKLY GOAL _____			
DAY	DATE	DISTANCE	CALORIES	TIME	COMMENTS
SUNDAY					
MONDAY					
TUESDAY					
WEDNESDAY					
THURSDAY					
FRIDAY					
SATURDAY					
WEEKLY TOTALS :					

WEEK # _____		WEEKLY GOAL _____			
DAY	DATE	DISTANCE	CALORIES	TIME	COMMENTS
SUNDAY					
MONDAY					
TUESDAY					
WEDNESDAY					
THURSDAY					
FRIDAY					
SATURDAY					
WEEKLY TOTALS :					

WEEKLY LOG SHEETS

WEEK # _____		WEEKLY GOAL _____			
DAY	DATE	DISTANCE	CALORIES	TIME	COMMENTS
SUNDAY					
MONDAY					
TUESDAY					
WEDNESDAY					
THURSDAY					
FRIDAY					
SATURDAY					
WEEKLY TOTALS :					

WEEK # _____		WEEKLY GOAL _____			
DAY	DATE	DISTANCE	CALORIES	TIME	COMMENTS
SUNDAY					
MONDAY					
TUESDAY					
WEDNESDAY					
THURSDAY					
FRIDAY					
SATURDAY					
WEEKLY TOTALS :					

WEEK # _____		WEEKLY GOAL _____			
DAY	DATE	DISTANCE	CALORIES	TIME	COMMENTS
SUNDAY					
MONDAY					
TUESDAY					
WEDNESDAY					
THURSDAY					
FRIDAY					
SATURDAY					
WEEKLY TOTALS :					

MAINTENANCE

Cleanliness of your treadmill and its operation environment will keep maintenance problems and service calls to a minimum. For this reason, we recommend that the following preventive maintenance schedule be followed.

AFTER EACH USE (DAILY)

Clean and inspect, following these steps:

- Turn off the treadmill with the on/off switch, then unplug the power cord at the wall outlet.
- Wipe down the running belt, deck, motor cover, and console casing with a damp cloth. Never use solvents, as they can cause damage to the treadmill.
- Inspect the power cord. If the power cord is damaged, contact Horizon Fitness.
- Make sure the power cord is not underneath the treadmill or in any other area where it can become pinched or cut.
- Check the tension and alignment of the running belt. Make sure that the treadmill belt will not damage any other components on the treadmill by being misaligned.

EVERY WEEK

Clean underneath the treadmill, following these steps:

- Turn off the treadmill with the on/off switch, then unplug the power cord at the wall outlet.
- Move the treadmill to a remote location.
- Wipe or vacuum any dust particles or other objects that may have accumulated underneath the treadmill.
- Return the treadmill to its previous position.

EVERY MONTH - IMPORTANT!

- Turn off the treadmill with the on/off switch, then unplug the power cord at the wall outlet.
- Inspect all assembly bolts of the machine for proper tightness.
- Turn off the treadmill and wait 60 seconds.
- Wait until ALL LED lights turn off.
- Remove screws holding motor cover to the frame. Remove the lower mast bolts in order to slide the motor cover upwards. While sliding the motor cover up the masts, be careful not to scratch the paint. Prop up the motor cover to continue.
- Clean the motor and lower board area to eliminate any lint or dust particles that may have accumulated. Failure to do so may result in premature failure of key electrical components.
- Vacuum and wipe down the belt with a damp cloth. Vacuum any black/white particles that may accumulate around the unit. These particles may accumulate from normal treadmill use.

LUBRICATION

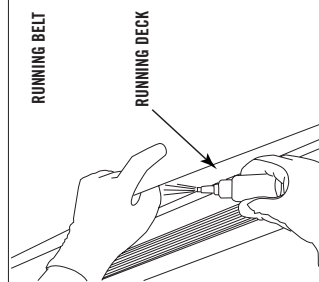

EVERY 6 MONTHS OR 150 MILES

It is necessary to lubricate your treadmill running deck every six months or 150 miles to maintain optimal performance of your treadmill. Once the treadmill reaches 150 miles, the console will prompt you to lubricate the treadmill. Only use lubricant provided by Horizon Fitness!

- **TURN OFF THE TREADMILL** with the on/off switch, then unplug the power cord at the wall outlet.
- Loosen both the rear roller bolts. (For best results, place two removable marks on both sides of the frame and note roller position). Once the belt is loosened, take the bottle of lubricant and apply it to the entire top surface of the running deck. Tighten both rear roller bolts (matching up the marks for proper position) to original position. After you have applied lubricant, plug in the power cord, insert the safety key, start the treadmill and walk on the belt for two minutes to spread the lubricant.
- Lubricate the air shocks with Teflon based spray.
- Once lubrication is complete, reset the console by pressing and holding 'STOP' and Speed +/- buttons for 5 seconds.

Please contact Horizon Fitness with questions about applying lubricant to your treadmill.

PROBLEM: The treadmill circuit breaker trips during a workout.

SOLUTION: Verify the following:

- Make sure the treadmill is plugged into a dedicated 20-amp circuit.
- Verify that you do not have the machine on an extension cord or surge protector.
- Confirm that the machine is not plugged into a GFCI-equipped outlet or on a circuit that has a GFCI-equipped outlet on it.

PROBLEM: The running belt does not stay centered during a workout.

SOLUTION: Verify the following:

- Make sure the treadmill is on a level surface.
- Verify that the belt is properly tightened and centered (Refer to the Adjustment section for detailed directions).

PROBLEM: Operating speed appears inaccurate.

SOLUTION: Auto-calibrate the treadmill:

- Power on the treadmill and have the safety key in position on the console. Press and hold the elevation "+", and speed "+", buttons for approximately 5 seconds to enter the Engineering Mode. The console will beep and "ENG2" appears in the display.
- Press the Speed "+", or "-", button until "ENG2" appears in the display.
- Press, "ENTER" to select. Press, "START" to begin. The treadmill running belt will begin to move automatically and the auto-calibration sequence will properly set and store the speed values.
- Upon successful calibration, the treadmill will beep several times. The console will automatically exit Engineering Mode and return to the start-up screen.



DO NOT stand on running belt while calibrating – stand on the guide rails. Treadmill will fluctuate between low and high speeds for several minutes until calibration is complete.

TROUBLESHOOTING - HEART RATE

Check your exercise environment for sources of interference such as fluorescent lights, computers, underground fencing, home security systems or appliances containing large motors. These items may cause erratic heart rate readouts.

You may experience an erratic readout under the following conditions:

- Gripping the heart rate handlebars too tight. Try to maintain moderate pressure while holding onto the heart rate handlebars.
- Constant movement and vibration due to consistently holding the heart rate handlebars while exercising. If you are receiving erratic heart rate readouts, try to only hold the grips long enough to monitor your heart rate.
- When you are breathing heavily during a workout.
- When your hands are constricted by wearing a ring.
- When your hands are dry or cold. Try to moisten your palms by rubbing them together to warm.
- Anyone with heavy arrhythmia.
- Anyone with arteriosclerosis or peripheral circulation disorder.
- Anyone whose skin on the measuring palm is especially thick.

If the above troubleshooting section does not remedy the problem, discontinue use and turn the power off.

PLEASE CALL CUSTOMER TECH SUPPORT AT THE NUMBER ON THE BACK PANEL.

The following information may be asked of you when you call. Please have these items readily available:

- Model Name
- Serial Number
- Date of Purchase (receipt or credit card statement)

In order for Customer Tech Support to service your treadmill they may need to ask detailed questions about the symptoms that are occurring. Some troubleshooting questions that may be asked are:

- How long has this problem been occurring?
- Does this problem occur with every use? With every user?
- If you are hearing a noise, does it come from the front or the back? What kind of noise is it (thumping, grinding, squeaking, chirping etc.)?
- Has the machine been lubricated and maintained per the maintenance schedule?

Answering these and other questions will give the technicians the ability to send proper replacement parts and the service necessary to get you and your Horizon Fitness treadmill running again!

LIMITED HOME-USE WARRANTY

EXCLUSIONS AND LIMITATIONS

Who IS covered:

- The original owner and is not transferable.

What IS covered:

- Repair or replacement of a defective motor, electronic component, or defective part and is the sole remedy of the warranty.

What IS NOT covered:

- Normal wear and tear, improper assembly or maintenance, or installation of parts or accessories not originally intended or compatible with the equipment as sold.
- Damage or failure due to accident, abuse, corrosion, discoloration of paint or plastic, neglect, theft, vandalism, fire, flood, wind, lightning, freezing, or other natural disasters of any kind, power reduction, fluctuation or failure from whatever cause, unusual atmospheric conditions, collision, introduction of foreign objects into the covered unit, or modifications that are unauthorized or not recommended by Horizon Fitness.
- Incidental or consequential damages. Horizon Fitness is not responsible or liable for indirect, special or consequential damages, economic loss, loss of property, or profits, loss of enjoyment or use, or other consequential damages of whatsoever nature in connection with the purchase, use, repair or maintenance of the equipment.
- Equipment used for commercial purposes or any use other than a single family or household, unless endorsed by Horizon Fitness for coverage.
- Equipment owned or operated outside the US and Canada.
- Delivery, assembly, installation, setup for original or replacement units or labor or other costs associated with removal or replacement of the covered unit.
- Any attempt to repair this equipment creates a risk of injury. Horizon Fitness is not responsible or liable for any damage, loss or liability arising from any personal injury incurred during the course of, or as a result of any repair or attempted repair of your fitness equipment by other than an authorized service technician. All repairs attempted by you on your fitness equipment are undertaken AT YOUR OWN RISK and Horizon Fitness shall have no liability for any injury to the person or property arising from such repairs.

SERVICE/RETURNS

- In-home service is available within 150 miles of the nearest authorized repair center (Mileage beyond 150 miles from an authorized service center is the responsibility of the consumer).
- All returns must be pre-authorized by Horizon Fitness.
- Horizon Fitness' obligation under this warranty is limited to replacing or repairing, at Horizon Fitness' option, the same or comparable model at one of its authorized service centers.
- A Horizon Fitness authorized service center must receive all equipment for which a warranty claim is made. This equipment must be received with all freight and other transportation charges prepaid, accompanied by sufficient proof of purchase.
- Replacement units, parts and electronic components reconditioned to As-New Condition by Horizon Fitness or its vendors may sometimes be supplied as warranty replacement and constitute fulfillment of warranty terms.
- This warranty gives you specific legal rights, and your rights may vary from state to state.

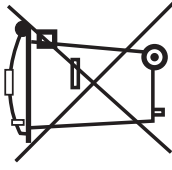

D:

Entsorgungshinweis

Horizon Fitness/Vision Fitness - Produkte sind recyclebar. Führen Sie das Gerät am Ende der Nutzungsdauer einer sachgerechten Entsorgung zu (örtliche Sammelstelle).

GB:

Waste Disposal

Horizon Fitness/Vision Fitness products are recyclable. At the end of its useful life please dispose of this article correctly and safely (local refuse sites).

F:

Remarque relative à la gestion des déchets

Les produits Horizon Fitness/Vision Fitness sont recyclables. À la fin sa durée d'utilisation, remettez l'appareil à un centre de gestion de déchets correct (collecte locale).

NL:

Verwijderingsaanwijzing

Horizon Fitness/Vision Fitness producten zijn recyclebaar. Breng het apparaat aan het einde van de gebruiksduur naa een op recycling gespecialiseerd bedrijf (plaatselijk verzamelpunt).

E:

Informaciones para la evacuación

Los productos de Horizon Fitness/Vision Fitness son reciclables. Cuando se termina la vida útil de un aparato o una máquina, entréguelos a una empresa local de eliminación de residuos para su reciclaje.

I:

Indicazione sullo smaltimento

I prodotti Horizon Fitness/Vision Fitness sono riciclabili. Quando l'apparecchio non servirà più, portatelo in un apposito punto di raccolta della Vostra città (Punti di raccolta comunali).

PL:

Wskazówka dotycząca usuwania odpadów.

Produkt firmy Horizon Fitness/Vision Fitness podlega recyklingowi. Pod koniec okresu o ywańności prosz oddać urządzenie do właściwego punktu usuwania odpadów (lokalny punkt zbiórny).

